



## **AOA/Pitot Probe**

P/N 100141-000

## **Heated AOA/Pitot Probe**

P/N 100667-000

*Includes instructions for installing:*

## **Pitot Mount for RV 7, RV-8, RV-9, RV-10**

P/N 102813-000

## **Pitot/Static/AOA Pneumatic Installation Kit**

P/N 102628-000

# **Installation Guide**

Document 100740-003, Revision G

August, 2023

Copyright © 2007-2023 by Dynon Avionics, Inc.

Permission to print this manual is granted to third parties

## Contact Information

Dynon Avionics, Inc.  
19825 141<sup>st</sup> Place NE  
Woodinville, WA 98072

### Technical Support

Phone: +1 (425) 224-6736, 8:00 AM – 5:00 PM (Pacific Time) Monday – Friday  
Email: [support@dynon.com](mailto:support@dynon.com)

### Sales

Phone: +1 (425) 650-1269, 8:00 AM – 5:00 PM (Pacific Time) Monday – Friday  
Email: [sales@dynon.com](mailto:sales@dynon.com)

## Find Us on the Web

[dynon.com](http://dynon.com) – Dynon homepage  
[dynon.com/docs](http://dynon.com/docs) – Product documentation  
[dynon.com/download](http://dynon.com/download) – Software updates for products  
[dynon.com/support](http://dynon.com/support) – Support resources  
[dynon.com/register](http://dynon.com/register) – Register your Dynon Avionics product  
[shop.dynon.com](http://shop.dynon.com) – Dynon’s *secure* online store

## Stay in Touch

[dynon.com/newsletter](http://dynon.com/newsletter) – Sign up to receive Dynon’s newsletter  
[forum.flydynon.com](http://forum.flydynon.com) – Dynon-hosted forum for customers and pilots  
[preflight.dynon.com](http://preflight.dynon.com) – Dynon’s blog  
[facebook.com/dynonavionics](https://facebook.com/dynonavionics)  
[instagram.com/dynonavionics](https://instagram.com/dynonavionics)  
[twitter.com/dynon](https://twitter.com/dynon)

## Videos and Training

[youtube.com/DynonAvionics](http://youtube.com/DynonAvionics) – Training, events, and other videos on YouTube

## Copyright

©2023 Dynon Avionics, Inc. All rights reserved. No part of this manual may be reproduced, copied, transmitted, disseminated or stored in any storage medium, for any purpose without the express written permission of Dynon Avionics. Dynon Avionics hereby grants permission to download a single copy of this manual and of any revision to this manual onto a hard drive or other electronic storage medium to be viewed for personal use, provided that such electronic or printed copy of this manual or revision must contain the complete text of this copyright notice and provided further that any unauthorized commercial distribution of this manual or any revision hereto is strictly prohibited.

Information in this document is subject to change without notice. Dynon Avionics reserves the right to change or improve its products and to make changes in the content without obligation to notify any person or organization of such changes. Visit the Dynon Avionics website ([dynon.com](http://dynon.com)) for current updates and supplemental information concerning the use and operation of this and other Dynon Avionics products.

## Limited Warranty

Dynon Avionics warrants this product to be free from defects in materials and workmanship for three years from date of shipment. Dynon Avionics will, at its sole option, repair or replace any components that fail in normal use. Such repairs or replacement will be made at no charge to the customer for parts or labor performed by Dynon Avionics. The customer is, however, responsible for any transportation cost and any costs that are incurred while removing, reinstalling, or troubleshooting the product. This warranty does not cover failures due to abuse, misuse, accident, improper installation or unauthorized alteration or repairs.

THE WARRANTIES AND REMEDIES CONTAINED HEREIN ARE EXCLUSIVE, AND IN LIEU OF ALL OTHER WARRANTIES EXPRESSED OR IMPLIED, INCLUDING ANY LIABILITY ARISING UNDER WARRANTY OF MERCHANTABILITY OR FITNESS FOR A PARTICULAR PURPOSE, STATUTORY OR OTHERWISE. THIS WARRANTY GIVES YOU SPECIFIC LEGAL RIGHTS, WHICH MAY VARY FROM STATE TO STATE AND IN COUNTRIES OTHER THAN THE USA.

IN NO EVENT SHALL DYNON AVIONICS BE LIABLE FOR ANY INCIDENTAL, SPECIAL, INDIRECT OR CONSEQUENTIAL DAMAGES, WHETHER RESULTING FROM THE USE, MISUSE OR INABILITY TO USE THIS PRODUCT OR FROM DEFECTS IN THE PRODUCT. SOME STATES AND COUNTRIES DO NOT ALLOW THE EXCLUSION OF INCIDENTAL OR CONSEQUENTIAL DAMAGES, SO THE ABOVE LIMITATIONS MAY NOT APPLY TO YOU.

Dynon Avionics retains the exclusive right to repair or replace the instrument or Software or offer a full refund of the purchase price at its sole discretion. SUCH REMEDY SHALL BE YOUR SOLE AND EXCLUSIVE REMEDY FOR ANY BREACH OF WARRANTY.

These instruments are not intended for use in type certificated aircraft at this time. Dynon Avionics makes no claim as to the suitability of its products in connection with FAR 91.205.

Dynon Avionics' products incorporate a variety of precise, sensitive electronics. SkyView products do not contain any field/user-serviceable parts. Units found to have been taken apart may not be eligible for repair under warranty. Additionally, once a Dynon Avionics unit is opened up, it is not considered airworthy and must be serviced at the factory.

Dynon Avionics Returns and Warranty web page can be found at [dynon.com/warranty](http://dynon.com/warranty).

## Revision History

Revision	Revision Date	Description
A	February, 2007	<ul style="list-style-type: none"> <li>● Initial release</li> <li>● P/N 100740-000</li> </ul>
B	February, 2007	<ul style="list-style-type: none"> <li>● Changed references to the tube being sealable to note the likelihood of a leak.</li> <li>● Document number remains 100740-000</li> </ul>
C	October, 2014	<ul style="list-style-type: none"> <li>● Combined AOA/Pitot Probe Installation Manual and Heated AOA/Pitot Probe Installation Manual.</li> <li>● Extensively updated concurrent with release of redesigned Heated AOA/Pitot Probe.</li> <li>● Document number changed to 100740-001</li> <li>● 29 pages</li> </ul>
D	May, 2016	<ul style="list-style-type: none"> <li>● Added instructions for installation of Pitot Mount for RV 7, 8, 9, 10 – Section 4</li> <li>● Added instructions for installation of Pitot/Static/AOA Pneumatic Installation Kit – Page 5-5 and later</li> <li>● Corrected incorrect fuse value (15A) on controller diagram (now 10A)</li> <li>● Added reference captions to all Figures and Tables</li> <li>● Added connector information for Heated AOA/Pitot Probe sensor wiring</li> <li>● Document number changed to 100740-002</li> <li>● 42 pages</li> </ul>
E	June, 2022	<ul style="list-style-type: none"> <li>● Revised Figures 3, 6, and 7 to include more detail.</li> <li>● Converted Figures 8, 9, 10, and 11 to drawings for readability.</li> <li>● Simplified and combined Figures 12 and 13.</li> <li>● Updated and split Figure 16 between Pitot/AoA and Static.</li> <li>● Document number changed to 100740-003.</li> </ul>
F	June, 2023	<ul style="list-style-type: none"> <li>● Updated part number in materials table on page 5-7.</li> <li>● Document number remains 100740-003.</li> </ul>
G	August, 2023	<ul style="list-style-type: none"> <li>● Added note about interference fit between probe and mast on page 5-2.</li> <li>● Updated Figure 12 for interference fit.</li> <li>● Document number remains 100740-003.</li> </ul>

**Table 1 – Revision History**

# Table of Contents

Contact Information.....	ii
Find Us on the Web.....	ii
Stay in Touch.....	ii
Videos and Training.....	ii
Copyright.....	ii
Limited Warranty.....	iii
Revision History.....	iv
<b>1. Introduction</b>	<b>1-1</b>
<hr/>	
AOA Calculation: Principles of Operation.....	1-4
What is Angle of Attack, why is it important, and who uses it?.....	1-4
Dynon Avionics' AOA/Pitot Probe.....	1-4
Airflow: Principles of Operation.....	1-5
Easy Installation and Calibration.....	1-5
Presentation.....	1-5
Heating: Principles of Operation.....	1-6
Failure Warning.....	1-6
Further Reading on Angle of Attack.....	1-6
<b>2. Technical Service Bulletin for Heated AOA/Pitot Probe</b>	<b>2-1</b>
<hr/>	
Unaffected Products.....	2-1
Affected Products.....	2-1
<b>3. Heater Controller Mounting and Wiring</b>	<b>3-1</b>
<hr/>	
Tools and Materials Required.....	3-1
Mounting the Controller.....	3-2
Wiring the Controller.....	3-2
Wiring System Overview.....	3-4
Probe to Controller Wiring.....	3-4
Controller Power and Pitot Heat Status Indicator Wiring.....	3-5
Pitot Heat Status.....	3-5
Heated AOA/Pitot Probe Sensor Wiring Connectors.....	3-6
<b>4. Pitot Mount for RV 7, RV-8, RV-9, RV-10 Installation</b>	<b>4-1</b>
<hr/>	
Included Materials and Parts.....	4-1
Recommended and Necessary Tools.....	4-1
Cutting Template.....	4-2
Mast Slot.....	4-3
Rivet Mounting Holes.....	4-4
1"x 1" Bracket.....	4-5
Final Installation.....	4-6
<b>5. AOA/Pitot Probe Mounting and Plumbing</b>	<b>5-1</b>
<hr/>	
Tools and Materials Required.....	5-1
Mounting.....	5-1
Mounting Location.....	5-1
Mounting Instructions.....	5-2
Dimensions.....	5-3
Plumbing.....	5-4
Pitot/Static/AOA Pneumatic Installation Kit.....	5-5
Recommended Tools.....	5-8
Installation.....	5-8
Moisture Drainage.....	5-12
Pressure Check.....	5-13



---

Heated AOA/Pitot Probe – Heater Check.....	5-13
Heated AOA/Pitot Probe – Pitot Heat Status Indicator Check (If Installed) .....	5-13
Polishing Your Dynon Avionics AOA/Pitot Probe .....	5-13
<b>6. AOA Configuration and Calibration</b>	<b>6-1</b>
<b>7. Specifications</b>	<b>7-1</b>

---

Pitot Mount for RV 7, RV-8, RV-9, RV-10 P/N 102813-000 .....	7-1
AOA/Pitot Probe P/N 100141-000 .....	7-1
Heated AOA/Pitot Probe P/N 100667-000.....	7-1
Heated AOA/Pitot Probe Controller .....	7-1

## 1. INTRODUCTION

---



The symbol to the left indicates information which merits special attention.



The symbol to the left indicates a handy installation tip.

Thank you for your purchase of the AOA/Pitot Probe (Dynon Avionics P/N 100141-000) or the Heated AOA/Pitot Probe (Dynon Avionics P/N 100667-000). This guide provides some background on the concept of angle of attack and explains the steps to install both units in your aircraft.

This manual does not address installation of the Dynon Avionics AOA/Pitot *Boom* Probe, P/N 100532-000.

The two probes are compatible with the following Dynon Avionics products:

- EFIS-D6
- EFIS-D60
- EFIS-D10A
- EFIS-D100
- FlightDEK-D180
- SkyView system
- SkyView SE system

(Hereafter, the EFIS-x and FlightDEK-D180 are referred to as “EFIS unit”).

### **AOA/Pitot Probes and AOA products from Advanced Flight Systems, Inc. (AFS)**



The Dynon Avionics AOA/Pitot Probe (P/N 100141-000) is functionally equivalent to the AFS Pitot Probe Unheated - Underwing, P/N 44300.

The Dynon Avionics Heated AOA/Pitot Probe (P/N 100667-000) is functionally equivalent to the AFS Pitot Probe Heated – Underwing, P/N 44310.

Instructions for installation of AFS products are in the AFS product manuals at [advancedflightsystems.com](http://advancedflightsystems.com).

After physical installation is complete, the AOA/Pitot Probe must be calibrated for your airplane and your system. Instructions for AOA/Pitot Probe calibration are contained in the Installation manual for each compatible Dynon Avionics system. Installation manuals for these products can be found at: [dynon.com/docs](http://dynon.com/docs).

The pitot function of the Dynon Avionics AOA pitot probe measures pitot pressure. This allows it to work with any standard airspeed indicator. However, the AOA functionality is designed specifically to work with Dynon Avionics and Advanced Flight Systems products. Do not expect a

Dynon Avionics AOA/Pitot Probe or Heated AOA/Pitot Probe to work properly with any AOA system other than those of Dynon Avionics or Advanced Flight Systems.



To display angle of attack on a Dynon Avionics EFIS unit or SkyView System, *only a Dynon Avionics AOA/Pitot Probe or Heated AOA/Pitot Probe is supported*. Using another manufacturer's or homemade AOA/Pitot probe may not produce accurate AOA information.



To ensure accuracy, it is very important that you install the probe correctly and perform the specified calibration steps. We recommend that you read and understand this entire manual and the corresponding calibration procedure in your EFIS unit's Installation Manual or SkyView / SkyView SE System Installation Guide before proceeding with installation.



The exterior of Dynon Avionics' AOA/Pitot Probes and Heated AOA/Pitot Probes exterior are plated. Do not polish the probe – doing so could abrade the finish.

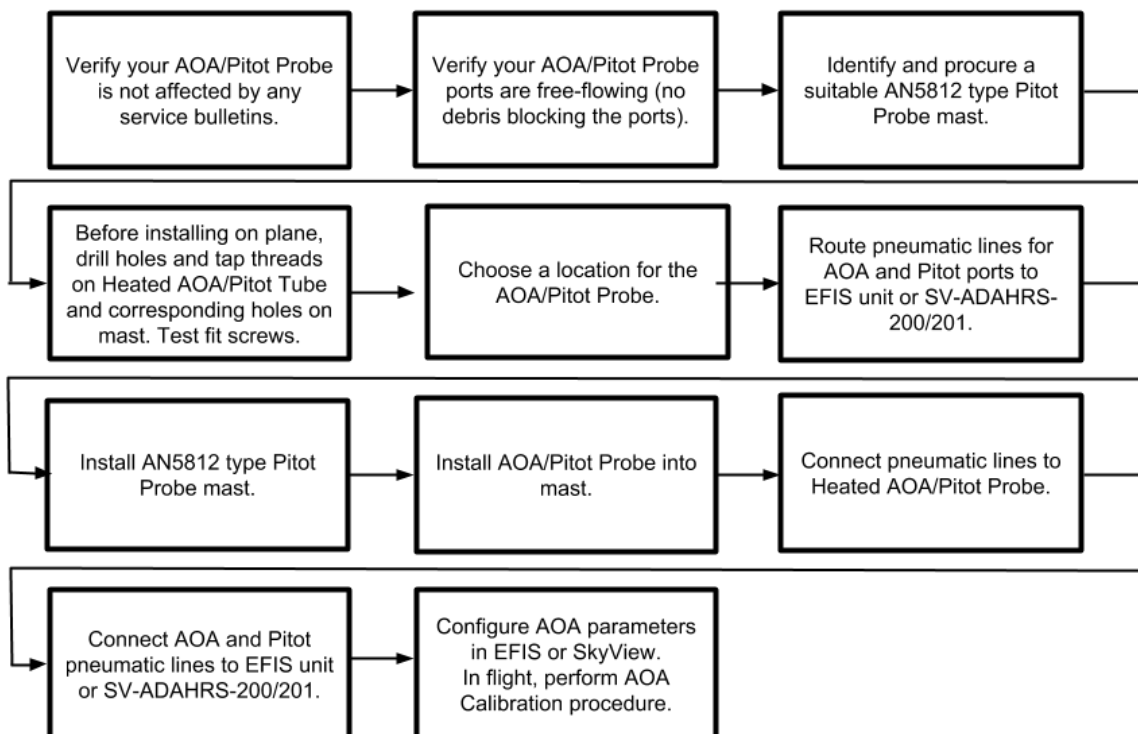

Figure 1 – Block diagram of major steps for installation of AOA/Pitot Probe



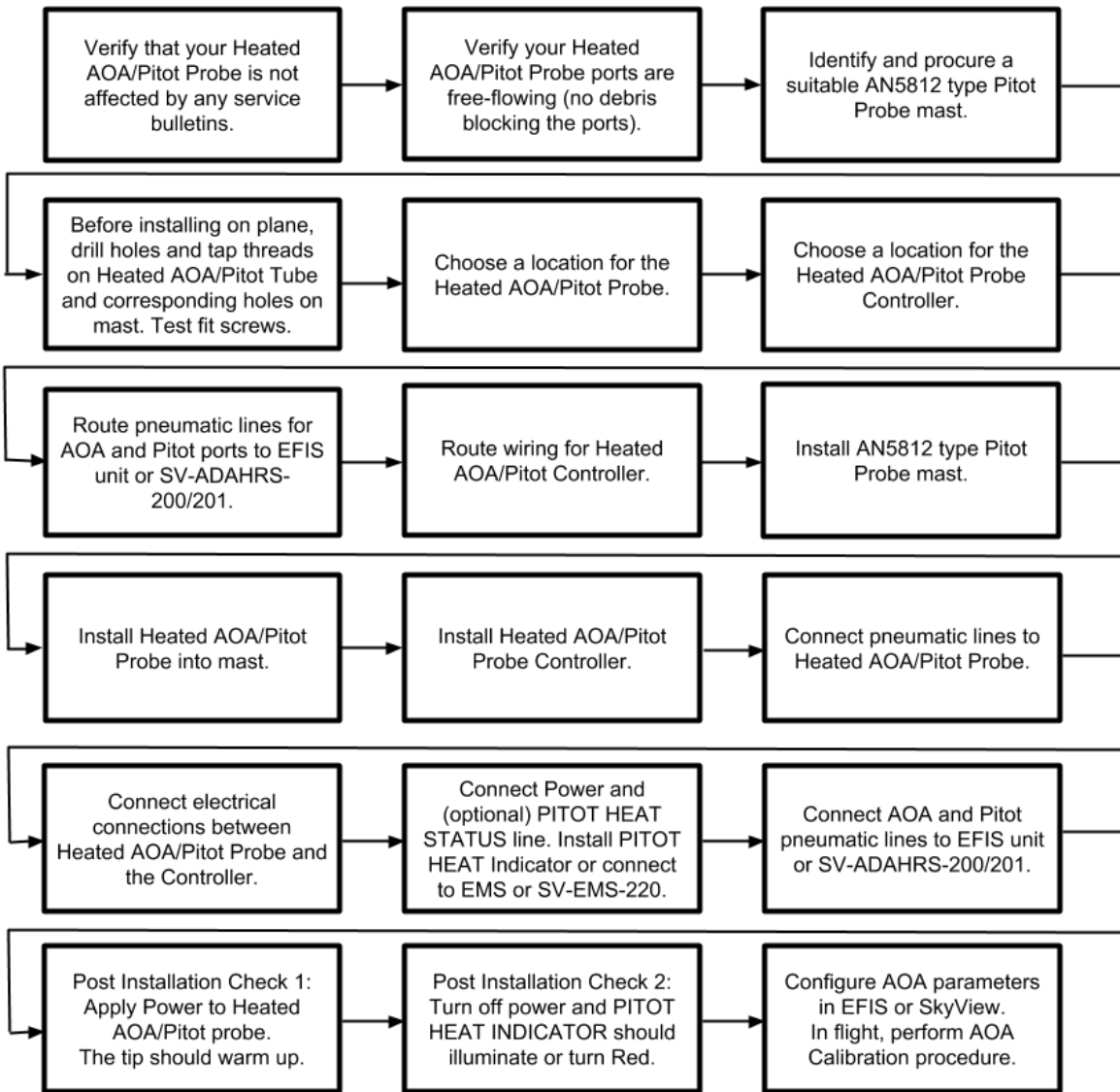

Figure 2 - Block diagram of major steps for installation of Heated AOA/Pitot Probe

## **AOA Calculation: Principles of Operation**

Most pilots are introduced to the concept of angle of attack (AOA) during their initial flight training. However, as most GA aircraft do not provide a way to directly measure this critical flight parameter.

### ***WHAT IS ANGLE OF ATTACK, WHY IS IT IMPORTANT, AND WHO USES IT?***

Angle of attack is quite simply the angle between the wing chord and the oncoming air that the wing is flying through. This is an important concept, as aircraft wings stall when angle of attack gets too large, at a value known as the “critical” angle of attack. As pilots are taught in flight training, an aircraft can stall at ANY speed if this critical angle of attack is exceeded. Hence, a great way to avoid stalls is to not let the angle of attack reach critical, and the best way to avoid critical angle of attack is to know what your angle of attack is in the first place.

Navy pilots know angle of attack well. On carrier approach, they use angle of attack measurement almost exclusively to determine if they are set up correctly for their “trap”. If their angle of attack is too high, they risk stall before reaching the carrier. If it is too low they will be carrying too much speed to land safely on the small patch of available deck space.

Airliners also rely on angle of attack information. Some make it directly available to the pilot via a dedicated gauge or readout. Others incorporate it into the data that it uses to warn pilots about impending stalls via stick shakers and other annunciators. In both cases, the pilot is able to make better decisions because they are able to incorporate information about the measured performance of their aircraft.

### ***DYNON AVIONICS' AOA/PITOT PROBE***

Dynon Avionics was the first manufacturer of affordable EFIS products to offer a way to measure Angle of Attack (AOA). Through extensive wind tunnel testing, Dynon Avionics is able to offer an Angle of Attack (AOA) / Pitot Probe that allows both angle of attack and airspeed to be measured when connected to the EFIS unit or SkyView system. AOA can be shown graphically on Dynon Avionics EFIS units and SkyView Primary Flight Display screen, and optionally listened to via audible alerting that intensifies as the critical Angle of Attack (stall) approaches.

### AIRFLOW: PRINCIPLES OF OPERATION

The concept behind Dynon Avionics' design is illustrated in the diagrams at right. The Dynon Avionics AOA/Pitot probe performs two functions: airspeed sensing and angle of attack sensing. These functions require having two pressure ports on the tip of the probe. The normal pitot pressure port is on the front face of the probe and is designed to be insensitive to angle of attack. The second pressure port is located on an angled surface just under the pitot port and is designed to be very sensitive to AOA.

The pressure from each port is delivered via separate pneumatic lines to the EFIS unit or SkyView System's ADAHRS module(s). Those pressures are compared to previously calibrated scenarios specific to that aircraft to calculate the current angle of attack.

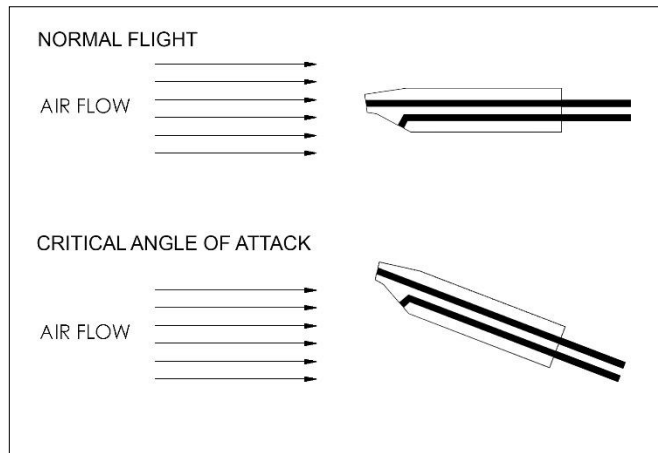

Figure 3 – Principles of Angle of Attack

### EASY INSTALLATION AND CALIBRATION

Unlike other AOA instruments available to homebuilders, the Dynon Avionics AOA/Pitot probes do not require you to drill special ports in wing skins. It also does not have any moving parts such as vanes. It is simply an AN5812-style pitot tube with an additional pressure port to measure AOA. Simply use it as a normal pitot tube. The only difference is a second plumbing line which runs back to the EFIS products or the SkyView SV-ADAHRS-200/201(s) for AOA calculation.

Once installed, the AOA/Pitot is calibrated to the individual aircraft by performing a series of pitch oscillations and stalls in various flight configurations. All calibration procedures are performed via button pushes on the EFIS unit or SkyView display.

### PRESENTATION

As shown on the right, angle of attack is displayed as a vertical color-coded tape with

- Red (down arrow at top)
- Yellow (down / horizontal lines in middle)
- Green (horizontal lines at bottom).

Once calibrated, critical angle of attack will be indicated with the pointer positioned in the red area of the tape.

An audio alarm can also be generated as AOA becomes critical. It can be set as either a steady tone that sounds very near the critical AOA, or alternatively as a progressive beeping tone that starts as AOA becomes moderately high and increases in frequency until it is a solid tone very near the critical AOA.



Figure 4 – AOA Icon

## Heating: Principles of Operation

Dynon Avionics Heated AOA/Pitot Probe utilizes a heating element whose temperature is accurately measured and regulated by a microprocessor-based controller. The controller monitors a temperature sensor embedded within the pitot body to regulate the heat for the front half of the Probe to a constant temperature. There are several advantages to this, including:

- Lower power consumption,
- Increased heating element lifespan,
- Much cooler pitot on the ground when de-icing is not necessary.

This technique ensures that the pitot can be rapidly de-iced if required, but does not needlessly waste electrical power when not in icing conditions.

The controller module is remotely mounted, in the wing near the probe, or elsewhere. See Probe to Controller Wiring, and Controller Power Wiring for wiring considerations on where to mount the controller.



While the Heated AOA/Pitot Probe does not operate like a normal (when switched on, always hot) heated pitot, *it will still get hot in normal ambient temperatures.* When turned on, it will soon regulate its internal temperature to about 158° F (70° C) to 176°F (80°C). Initial temperatures can be as high as 194°F (90°C). These temperatures can cause a burn if touched with bare skin for long.

### **FAILURE WARNING**

The controller for the Dynon Avionics Heated AOA/Pitot Probe is designed to meet the indication requirements of FAR 23.1326 by providing an output that can illuminate a PITOT HEAT STATUS warning indicator in the cockpit whenever the probe heater is turned off or is not functioning properly. While this is not required for Experimental and LSA category aircraft, this feature provides feedback that your Heated AOA/Pitot Probe's heater is working as designed.

### **FURTHER READING ON ANGLE OF ATTACK**

Like many aspects of flight, AOA is a simple concept that needs to be well understood to be truly useful. The following are some resources that explain AOA and its application:

- John S. Denker: "See How it Flies" website, Angle of Attack Awareness and Angle of Attack Management - <http://www.av8n.com/how/htm/aoa.html>.
- AOPA Air Safety Foundation online article "The Angle's the Thing" - <http://www.aopa.org/News-and-Video/All-News/1994/August/1/The-angles-the-thing>.

## 2. TECHNICAL SERVICE BULLETIN FOR HEATED AOA/PITOT PROBE

---

On May 6, 2014, Dynon Avionics issued a Technical Service Bulletin that discussed an issue with previously-manufactured Dynon Avionics Heated AOA/Pitot Probes (P/N 100667-000). It was subsequently updated in October 2014 with instructions to obtain a redesigned probe that fixes the identified issue. Customers that have Heated AOA/Pitot Probes that are affected by this Technical Service Bulletin should not proceed with installation. Your probe should be replaced via Dynon Avionics' Heated AOA/Pitot Probe replacement program.

For details, see the latest Heated AOA/Pitot Probe Service Bulletin at [dynon.com/support](http://dynon.com/support).

### **UNAFFECTED PRODUCTS**

This Technical Service Bulletin *does not affect*:

- Controller module (P/N 100640-000) for the Dynon Avionics Heated AOA/Pitot Probe
- Dynon Avionics AOA/Pitot Probe P/N 100141-000
- Dynon Avionics AOA/Pitot Boom Probe P/N 100532-000

If you are installing a Dynon Avionics Heated AOA/Pitot Probe, ensure that the unit you have is not affected by the Technical Service Bulletin by comparing your probe to the illustration at right. Orient your probe snout up, looking at the bottom side of the Probe opposite the mounting "elbow".

If your Dynon Avionics Heated AOA/Pitot Probe matches the illustration at right – has two pin-size drainage holes along the centerline, directly behind the snout, your unit is not affected by this Technical Service Bulletin and no action is required; continue the installation.

### **AFFECTED PRODUCTS**

If either of the following criteria are met, your Heated AOA/Pitot Probe is affected by this Technical Service Bulletin and should be returned to Dynon Avionics to exchange it for the redesigned part:

- Any Heated AOA/Pitot Probe sold before October 2014 is affected by this Technical Service Bulletin.
- Any Heated AOA/Pitot Probe with a serial number lower than 6000 is affected by this Technical Service Bulletin. On affected Heated AOA/Pitot Probes, the serial number is etched on the mounting flange that is normally recessed into a mounting bracket. The

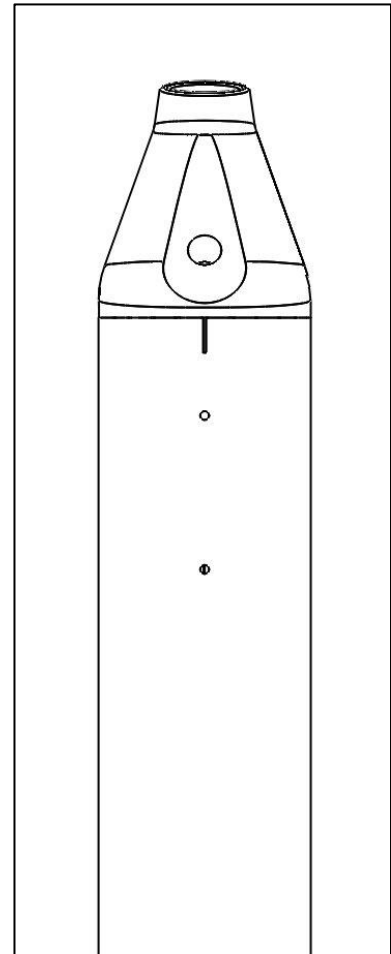

**Figure 5**  
**Illustration of an**  
**UNAFFECTED Heated**  
**AOA/Pitot Probe**

Heated AOA/Pitot Probe's controller has its own unique serial number that cannot be used to identify affected Heated AOA/Pitot Probes.



If your Heated AOA/Pitot Probe is replaced as part of the Technical Service Bulletin, after installing the replacement Heated AOA/Pitot Probe, you should re-perform the AOA Calibration procedures in your EFIS unit or SkyView System's Installation Manual to ensure correct angle of attack is displayed.

### 3. HEATER CONTROLLER MOUNTING AND WIRING

---



Please follow these instructions explicitly as improper installation can result in permanent damage to your device and/or aircraft.



**The Dynon Avionics Heated AOA/Pitot Probe operates on 12V only.** For aircraft with a 24V electrical system, a 24V-to-12V DC-DC converter, capable of supplying 10A, must be used to supply the required 12V at 10A.



The associated power wires and the controller for the Heated AOA/Pitot Probe will be a source of significant magnetic fields and thus can affect:

- Magnetic compass – ensure that there is reasonable separation of the wiring and the controller from a Dynon Avionics EDC-D10A remote magnetometer or SV-ADAHRS-200/201, or any other compass-type device that senses magnetic fields.
- Audio devices – ensure that there is reasonable separation of the wiring and the controller from wiring associated with audio systems, especially microphone circuits and intercoms.

Test for potential magnetic interference by turning on the Heated AOA/Pitot and check for compass deviation and interference to all audio systems.



PITOT HEAT POWER switch or circuit breaker:

When deciding when to turn the Heated AOA/Pitot Probe On or Off, remember that even when the Probe's power is On, it will only heat the probe the amount necessary to maintain temperature.

#### Tools and Materials Required

- Heated AOA/Pitot Probe Controller
- Appropriate fasteners
- 14 AWG, 12 AWG, or 10 AWG wire – see chart on page 3-2
- 10A circuit breaker or fuse
- PITOT HEAT POWER switch (if not using circuit breaker for switching)
- PITOT HEAT STATUS Indicator light or LED (or available Dynon Avionics EMS General Purpose Input)
- If installing in a 24V aircraft, a 24V-to-12V DC-DC converter, capable of supplying 10A

## Mounting the Controller

The Heated AOA/Pitot Probe controller should *ideally* be mounted close to the Heated AOA/Pitot Probe on the underside of the wing to not require extending the included wires connecting the Probe to the controller. As with all avionics units, the controller should be mounted such that it can be accessed should service or replacement ever be required.

The controller's overall dimensions are:

- Width: 5.04" (128.08mm)
- Depth: 1.74" (44.25mm)
- Height: 1.24" (31.60mm)

The mounting holes are sized for a #6 screw. Hole to hole dimensions are referenced in the diagram.

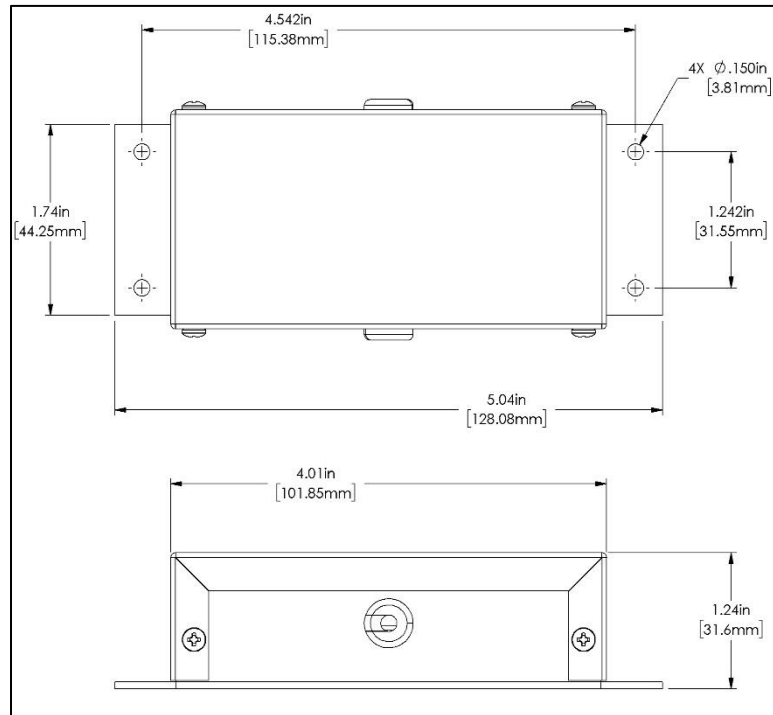

Figure 6 – Heated AOA/Pitot Controller Dimensions

When mounting the controller close to the probe, ensure that it is close enough for its wires to mate with the probe's, with room for strain relief. If you find it difficult to mount the controller in the wing, or simply wish for the controller to be mounted closer to the battery, you must extend the wires using the correct wire gauge per the chart below.

When the desired location is selected, secure the heater controller via the 4 mounting holes. Route the wiring between the probe, controller, panel, and power source, as described below.

## Wiring the Controller



For all electrical connections, use correct wiring techniques, taking care to properly insulate any exposed wire. A short circuit between any of the wires may cause damage to the Heated AOA/Pitot Probe, controller, or your airplane. Make all connections to the harnesses before plugging it into any of the components of the system. Do not make connections while power is applied at any point in the system.



Do not connect the Black (Ground) wire to the airframe as a Ground connection. Doing so will introduce high currents (10A) into the airframe. This can introduce a significant voltage drop, and potentially cause engine instrumentation, avionics, and audio system electrical problems.





All wires associated with the Dynon Avionics Heated AOA/Pitot Probe should have Tefzel insulation (Mil Standard M22759/16). To purchase such wire, specify M22759/16-xx where xx is the AWG size. For example, M22759/16-10 is 10 AWG wire with Tefzel insulation. We recommend that all wire used in your airplane have Tefzel insulation.

The included wires on the Heated AOA/Pitot Probe and the Heated AOA/Pitot Probe controller are appropriately sized (18 AWG) for their current requirements and lengths. It is preferable that the Heated AOA/Pitot Probe controller be mounted near enough to the probe that the 5 wires between the Probe and the controller can be connected without adding extension wiring between the two units. Route all wiring through the aircraft such that there are no spots where it could chafe or break. Use appropriate strain relief at all junctions between wires and connectors. Secure all wires at regular intervals along wiring runs to accommodate vibration effects. Use correctly-sized wire for the length of runs between the electrical distribution bus, controller, and probe, as shown in the chart to the right.

Recommended wire gauge for runs, given 10-amp peak current	
Run length	Gauge
~3.5' wiring included with units	
4' – 16'	14 AWG
17' – 24'	12 AWG
25' – 40'	10 AWG
Based on recommendations in FAA AC 43.13-1B, page 11-30	

**Table 2 – Power Wiring Length vs Wire Gauge**



In the recommended wire gauge chart above, the lengths shown are for the *entire run of wire*. Thus, the approximately 3.5' of wire included as part of the Heated AOA / Pitot Probe and the controller, should be taken into account. Example – if an additional 13.5' of wire is required to connect the controller to aircraft power, the overall run of wire is 17', which dictates the use of 12 AWG wire.

**WIRING SYSTEM OVERVIEW**

The following block diagram depicts the basic layout of the electrical connections between the probe and controller. This diagram should be used in conjunction with detailed instructions on the following pages. Read the specific instructions for each connection prior to installation.

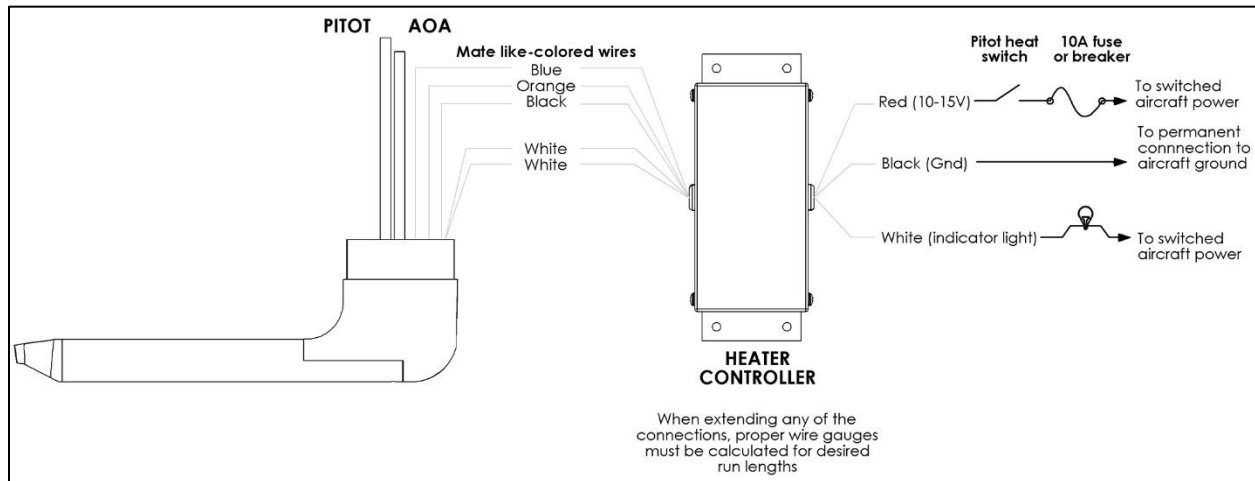

**Figure 7 – Heated AOA/Pitot Controller Connections**

**PROBE TO CONTROLLER WIRING**

As mentioned above, it is preferable that the Heated AOA/Pitot Probe controller be mounted close enough to the probe that 5 wires between the controller and probe can be connected without adding extension wiring. The three mating<sup>1</sup> pairs of colored wires – terminated with Faston connectors – are used to carry the current to the heating element in the probe. The 2 white wires are for temperature measurement, and can thus be small. If you have mounted the heater controller near the probe and do not need to extend the wires between the two, simply plug each wire on the controller into its corresponding like-colored wire from the probe.

If you do need to extend the wires between the probe and the controller, use the recommended wire size (see chart on page 3-3) to choose the correct size of wire. When extending the wires between probe and controller, we recommend the use of a secure, solid electrical connection such as a crimped butt splice connector. The white wires are not polarity-dependent and do not carry any significant current, thus you can use wire as small as 26 AWG, or larger, for any run length.

<sup>1</sup> In newer Heated AOA/Pitot Probes shipped after October 2014, the Blue and Orange wires are now White with a short length of Blue and Orange heat shrink tubing.

**CONTROLLER POWER AND PITOT HEAT STATUS INDICATOR WIRING**

Color	Function	Notes
<b>Red</b>	12-15V Power (+)	Connected through a pilot-accessible PITOT HEAT switch to 10–15V supply (via 10A circuit breaker or fuse). Wire must be sized to conduct 10A with minimal voltage drop – See Page 3-3.
<b>Black</b>	Ground (-)	Constant connection to ground (not routed through a switch or fuse / circuit breaker). Must be sized to conduct 10A with minimal voltage drop. Ground connection must be constant FOR PITOT HEAT STATUS LINE (White wire) to operate when the controller is powered Off or not functioning.
<b>White</b>	PITOT HEAT STATUS	Connected to a PITOT HEAT STATUS indicator light or indicator on a Dynon Avionics EMS. This line is grounded when the controller is powered Off or not functioning. This circuit can handle a maximum of 1A.

**Table 3 – Heated AOA/Pitot Power and Status Connections**
**PITOT HEAT STATUS**

The Dynon Avionics Heated AOA/Pitot Probe controller is designed to meet the indication requirements of FAR 23.1326 by providing an PITOT HEAT STATUS output that can illuminate a PITOT HEAT STATUS warning indicator in the cockpit whenever the Probe’s heater is turned Off or is not functioning properly. While this is not required for Experimental and LSA category aircraft, this feature provides feedback that your Heated AOA/Pitot Probe is working as designed. The Heated AOA/Pitot Probe functions properly whether or not you make this connection - it is merely a status output for your convenience.

The PITOT HEAT STATUS line (White wire) is grounded when the controller is turned off or not functioning properly. The PITOT HEAT STATUS line (White wire) can be connected to an indicator on the panel, whose other terminal is connected to Switched 12V<sup>2</sup>. When the Heated AOA/Pitot Probe is switched on and functioning properly, the PITOT HEAT STATUS line will be open (not grounded), leaving the indicator light turned off (no current is flowing). The PITOT HEAT STATUS line (White wire) can handle a maximum of 1A current, so choose the type of indicator carefully.

Aircraft Spruce P/N 17-410 is an example of an Indicator light that will work for this application. An LED and resistor in series will also suffice. If you use an LED as the indicator, you must

<sup>2</sup> If connected to always-on 12V, the PITOT HEAT STATUS indicator will always be on when the Heated AOA/Pitot Probe is switched Off)

choose a resistor that delivers the appropriate current to the LED, and can accommodate the power required for its current and voltage drop.

If you own a Dynon Avionics Engine Monitoring System (EMS-D10, EMS-D120, FlightDEK-D180), you can use one of the two Contact Inputs to display the state of the controller Status line (White wire). If you own a SkyView system with a SV-EMS-220/221 engine monitoring module, you may use one of its General Purpose Inputs, configured as a Contact Input, to display the state of the controller Status line (White wire). Connect the White wire to the desired EMS or SV-EMS-220 input pin with no additional resistors or indicators. You will need to configure the contact display as described in your EMS product's Installation manual / SkyView System / SkyView SE Installation Guide.

### ***HEATED AOA/PITOT PROBE SENSOR WIRING CONNECTORS***

If the small connectors on the Dynon Avionics Heated AOA/Pitot Probe, or Controller, are damaged or otherwise require replacement, following are the OEM part numbers. These parts are available from Digi-Key – <http://www.digikey.com>. *Note that the pins require a specialized crimping tool.*

On the Controller:

- Connector: Molex Microfit Female 2-position, with tabs, Molex P/N 43640-0200,  
Pins: Molex Microfit Male Pin, 26-30 AWG, P/N 43031-0010

On the Probe:

- Connector: Molex Microfit Male 2-position, Molex P/N 43645-0200,  
Pins: Molex Microfit Female Pin, 26-30 AWG, P/N 43031-0001

## **4. PITOT MOUNT FOR RV 7, RV-8, RV-9, RV-10 INSTALLATION**

---

Dynon Avionics offers a Pitot Mount for the RV-7, RV-8, RV-9, and RV-10 aircraft. The instructions below include a cutting template. These instructions are written for the most general construction issues encountered with these aircraft, but modifications may be necessary per the aircraft builder's preference and changes in construction of the aircraft.

### **Included Materials and Parts**

- Pitot Mast – A rectangular plate with the mast welded through a slot. The elbow of the pitot probe mounts into the mast.
- Cutting Template (102814-000) – Uses two lines to align on skin. Displays eight pilot hole locations and a slot for the mast using two holes and a pattern connecting the two.
- 1"x 1" Bracket (102809-000) – Small bracket with 90° bend for stabilizing the mast.

### **Recommended and Necessary Tools**

- Spray adhesive – Dynon recommends a spray adhesive for ease of mounting and insurance that the template will remain in one place. A spray adhesive such as 3M 77 can be found at local hardware stores or online.
- ½" Drill Bit – The upper radius of the mast slot is cut by drilling a ½" hole.
- 3/16" Drill Bit – The lower radius of the mast slot is cut by drilling a 3/16" hole.
- #40 Drill Bit – The mounting holes for riveting the bracket to the skin are a metric #40 hole.
- Powered or Hand Nibbler – An easy way to cut the remainder of the slot for the mast is by using a nibbler. This will give a relatively smooth edge to file down.
- Hand File – A file for aluminum is used to smooth the edges of the mast slot and adjust size.

## Cutting Template

The template provided is designed to make placing of the mast, drilling of the pilot holes, and cutting of the slot for the mast as easy as possible. Begin by drawing the “T” for the template, one line going through the center of the top row of rivet holes and the vertical being directly in between the 3rd and 4th rivet hole going right to left from the rib. Using some sort of adhesive (a spray adhesive is recommended), align the horizontal and vertical lines with those on the template. Take as much time as necessary to make sure that the template is properly aligned per builder’s preference and then that it is firmly adhered to the skin. It is imperative that the template does not move while drilling any of the pilot holes or cutting out the mast hole.

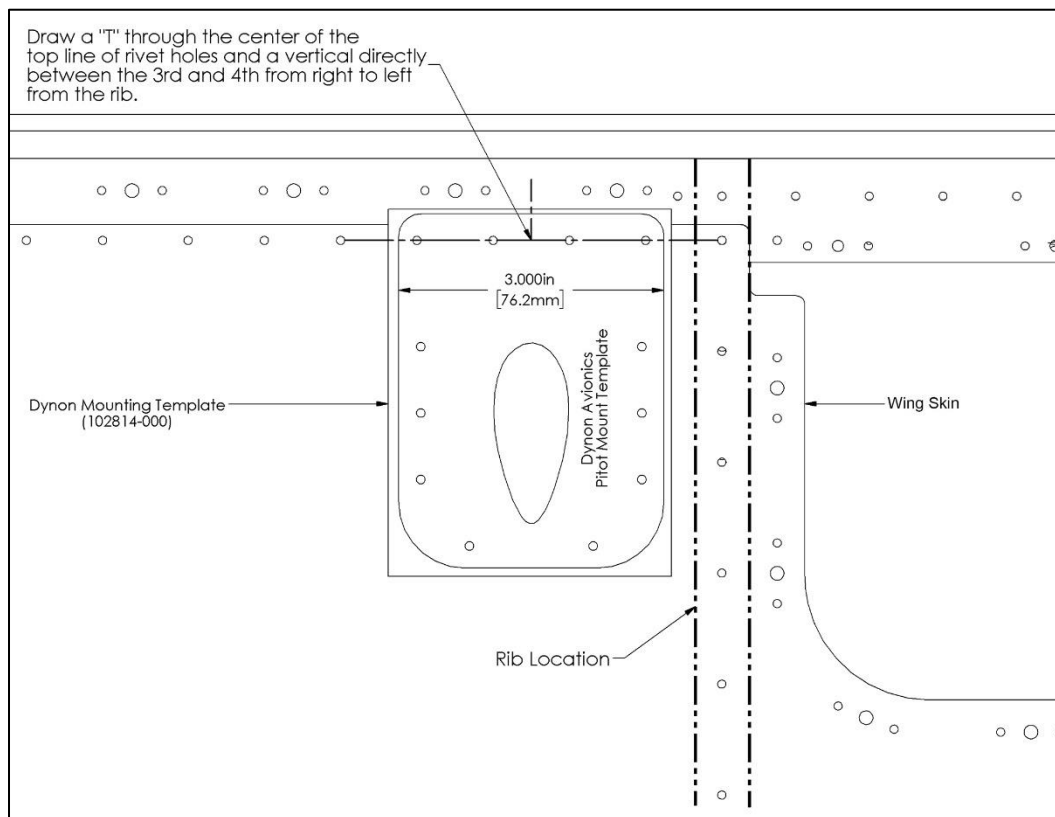

Figure 8 – Cutting Template

## Mast Slot

Use a 1/2" drill bit to cut the upper radius of the mast slot using the template as the guide for drilling. Use a 3/16" drill bit to cut the lower radius of the mast slot, again using the template to guide. Preferably using a nibbler, cut out the remaining edge of the slot for the mast. Absolute precision is not necessary and it is suggested you leave excess material since it can always be filed down if necessary. Use a hand file to smooth the edges of the mast slot and trim to size until the mast can slide through the slot.

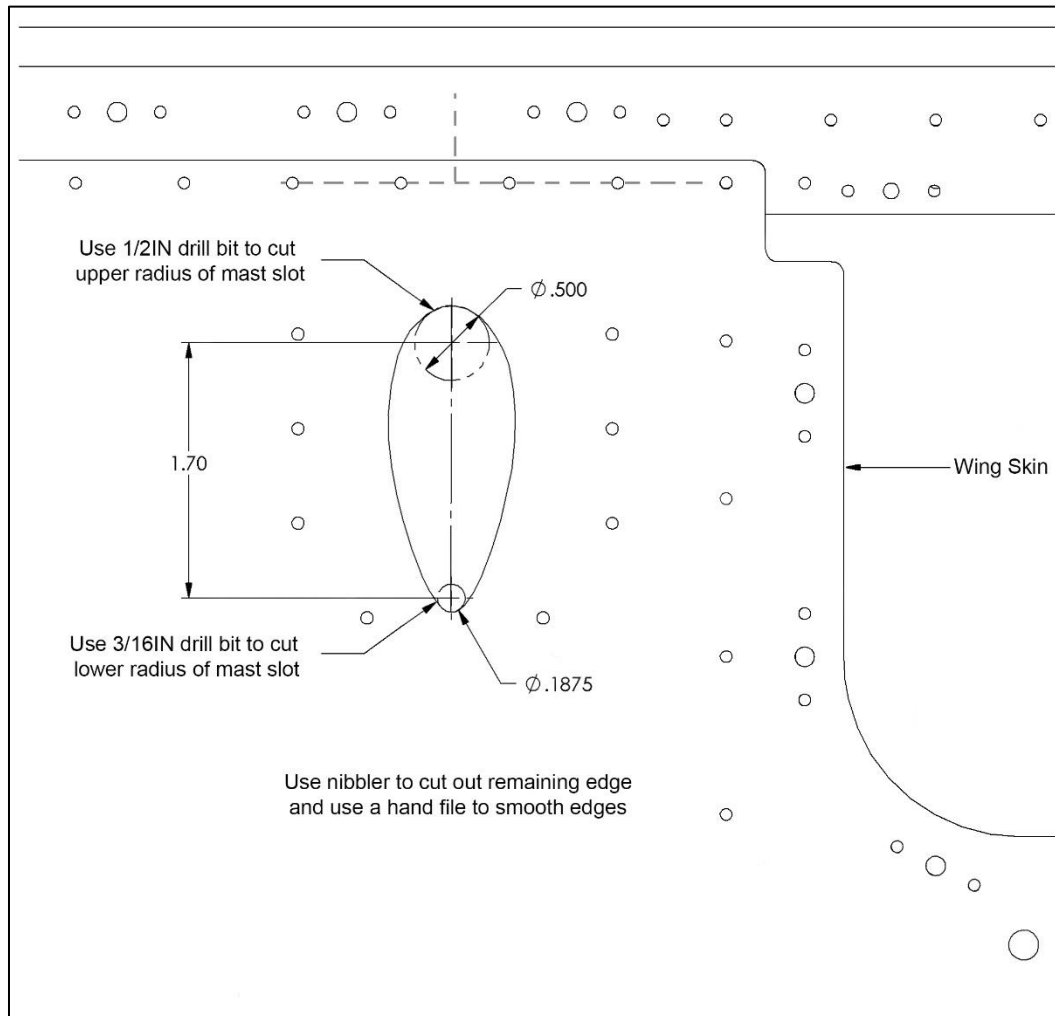
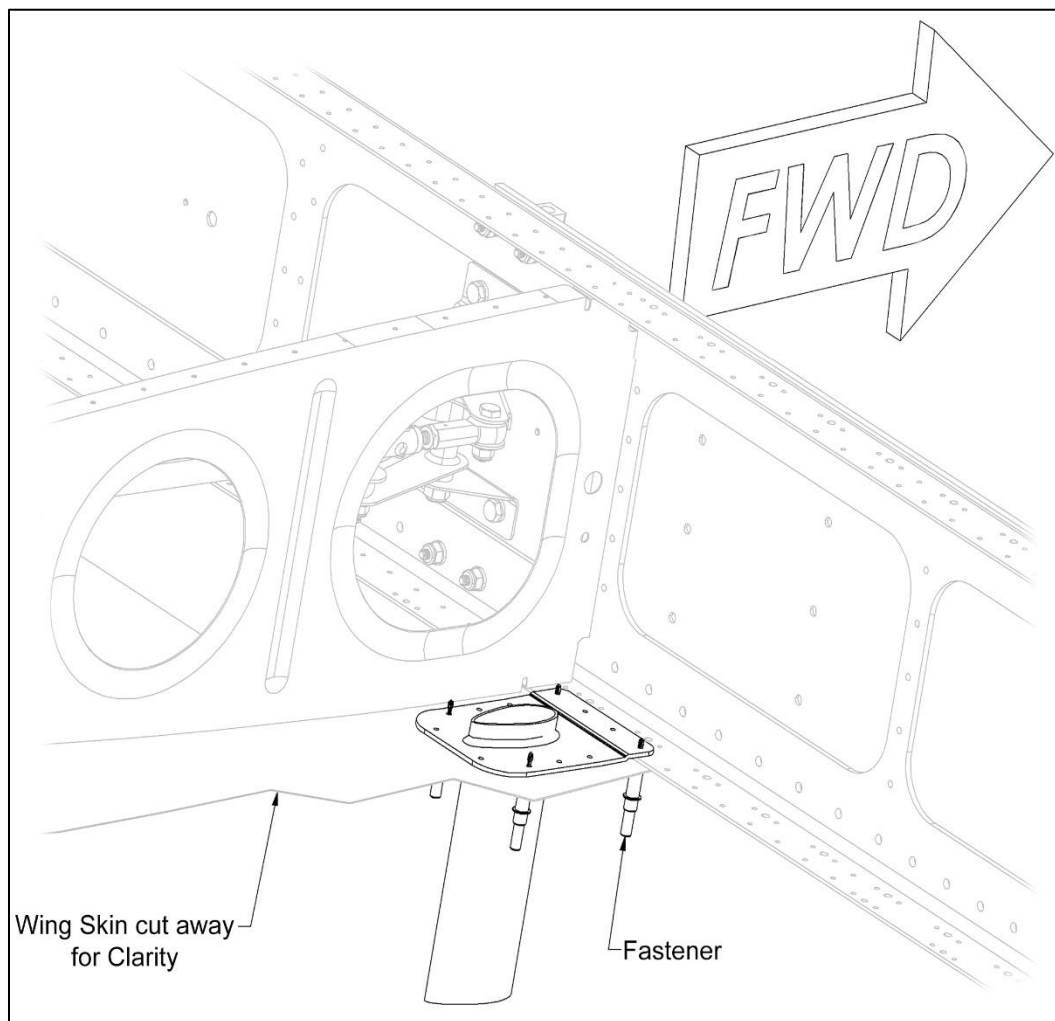

Figure 9 – Mast Installation in Progress

## Rivet Mounting Holes

Now that the mast has a secure slot to fit in, use any type of clamp or soft mounting technique to hold the mast in place with the bracket against the spar and wing skin in the position that it will be permanently mounted. You can even simply use your hand to hold it place temporarily. Once positioned correctly, use a #40 drill bit to match drill the four holes on top which correspond to the spar. We suggest starting with drilling the two outside holes and then using Clecos to hold the bracket in place while the rest of the holes are drilled. After match drilling the four holes that align with the spar, continue to drill the remaining eight rivet holes through both the skin and the bracket. Use Clecos as desired to maintain the bracket's position.

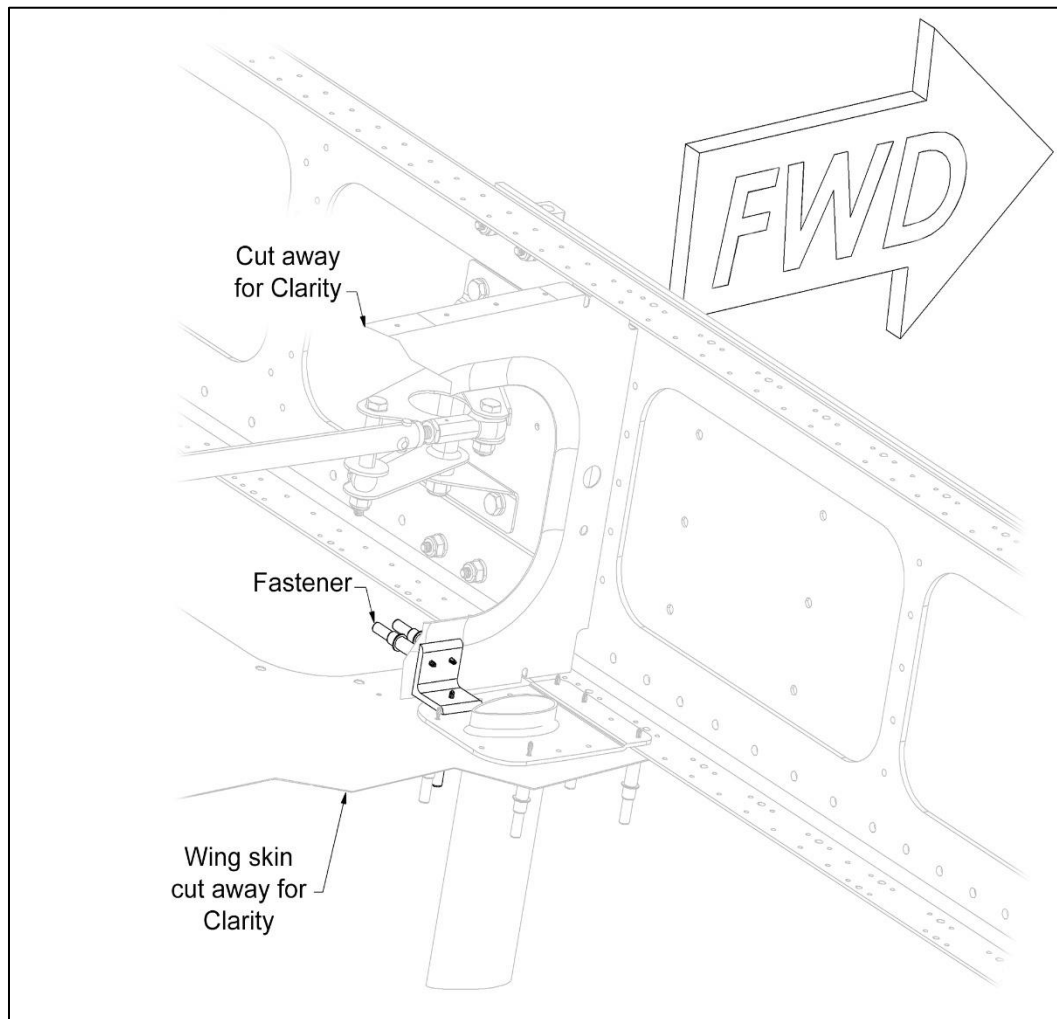

**Figure 10 – Mast Installed (with Clecos)**



### 1"x 1" Bracket

After all necessary holes have been drilled into the bracket and wing skin and the mast is temporarily mounted using Clecos, it's time to better stabilize the final mounting of the mast with the included 1"x 1" bracket. Although the specific installation of the 1"x 1" bracket may vary by aircraft but it cannot be excluded as it is essential to ensure a secure mount with expected loads. When looking at the mast bracket from inside the wing, the 1"x 1" bracket will attach to the bottom left hole of the column of three and then to the adjacent rib. Use a similar process of match drilling to drill the hole that connects to the mast bracket. Placement of the holes and how to connect the bracket to the adjacent rib can be determined by the builder.



**Figure 11 – Installation of Bracket**

---

## **Final Installation**

Complete the installation and final mounting of all parts when riveting on the lower wing skin.

The finish on the Dynon Avionics Pitot Mount is Gold Chem Film Plating (Alodine™). This finish is a good preparation for painting, but if you wish to polish the aluminum, the finish can be easily removed by using a polishing compound.

## 5. AOA/PITOT PROBE MOUNTING AND PLUMBING

---

### Tools and Materials Required

- RV-7, RV-8, RV-9, RV-10: Dynon Avionics Pitot Mount, P/N 102813-000.
- Other than RV-7, RV-8, RV-9, or RV-10: AN5812 type mast for under-wing mounting.
- Dynon Avionics AOA/Pitot probe or Dynon Avionics Heated AOA/Pitot Probe.
- Dynon Avionics Pitot/Static/AOA Pneumatic Installation Kit, P/N 102628-000
- If other than Dynon Avionics Pitot/Static/AOA Pneumatic Installation Kit...
  - Adapters as required connect with the 3/16" aluminum tubing from the Probe to the plumbing lines are installed in the airplane
  - AN919-2D for 3/16" to 1/4"
  - AN819-4D sleeve and AN818-4D nut
  - AN819-3D sleeve and AN818-3D nut
  - Two plumbing lines (usually 1/4" soft aluminum or plastic tubing) routed from the AOA/Pitot Probe to the EFIS unit or the SkyView system's SV-ADAHRS-200/201
- Appropriate fasteners
- Appropriate drill and tap

### Mounting

The Dynon Avionics AOA/Pitot Probe (P/N 100141-000) and Dynon Avionics Heated AOA/Pitot Probe (P/N 100667-000) are designed to be suspended vertically on the underside of a wing; the beveled face should be at the 6:00 position.



There is no provision in these products for horizontal mounting; the tip of the Probe is permanently installed and *cannot* be rotated.

See the TOOLS AND MATERIALS REQUIRED section above to obtain a suitable Pitot Mount for the Dynon Avionics AOA/Pitot Probe or Dynon Avionics Heated AOA/Pitot Probe.

#### ***MOUNTING LOCATION***

The Dynon Avionics AOA/Pitot Probe / Heated AOA/Pitot Probe will work correctly only when mounted in a location where the airflow over the probe is relatively undisturbed by the aircraft. In general, we recommend you mount it at least 6 inches (150mm) below the wing and with the tip of the probe between 2 inches (50mm) and 12 inches (300mm) behind the leading edge of the wing. Typically a pitot probe is mounted about mid-wingspan to minimize the effects of both the propeller and the wing tips. Testing during the development of the Dynon Avionics AOA/Pitot Probe / Heated AOA/Pitot Probe confirmed that the standard mounting locations for the pitot probe in the Van's Aircraft RV series of aircraft work well for a Dynon Avionics AOA/Pitot Probe / Heated AOA/Pitot Probe.

### ***MOUNTING INSTRUCTIONS***

After the mounting location has been determined, you will need to mount the pitot mounting kit per the included instructions or fabricate your own mount. In either case, mount the Dynon Avionics AOA/Pitot Probe / Heated AOA/Pitot Probe securely to rigid structure of the airframe. The body of the probe must be parallel to the wing chord.



Use caution when drilling the holes, ensuring that you avoid drilling into the pitot and AOA pressure lines. As long as you do not penetrate these lines, you may drill all the way through the outer metal without affecting the probe's waterproofing. As it is sometimes hard to control penetration depth when drilling with a hand drill, we recommend using a drill press to drill the holes only through the metal wall, and no further.



The fit between the AOA/Pitot Probe and the mast is designed to be an interference fit. If needed for the best fit, installers can lightly sand the portion of the probe that fits into the mast (see for Figure 12 exact location).

Some examples of Dynon Avionics AOA/Pitot Probe installation can be found on the web<sup>3</sup> at:

- RV-7A - John Harrell:  
<http://johnsrv7a.wordpress.com/category/wings/pitot-tube-mounting/> (many photos, including wing interior)
- RV-9A – Mike Hoover:  
<http://www.aclog.com/rv-9a/index.php?c=2> (search on the page for “Pitot” to find relevant descriptions and photos)
- RV-10 - Conrad Booze:  
<http://www.mykitlog.com/users/category.php?user=conrad&project=666&category=4589>
- Zenith STOL CH 750 - Victor Menkal:  
<http://www.zenith.aero/photo/dynon-heated-pitot-aoa-probe>

Note that these links are from third party websites and were verified as working 2016-05, but may expire. Comments and installation particulars contained on those web pages are those of the authors, and do not represent the views of Dynon Avionics.

---

<sup>3</sup> Search engine keywords: Dynon Avionics AOA/Pitot

### Dimensions

In the following illustrations, only the pneumatic lines are shown for clarity. The external dimensions of the AOA/Pitot Probe and Heated AOA/Pitot Probe are identical.

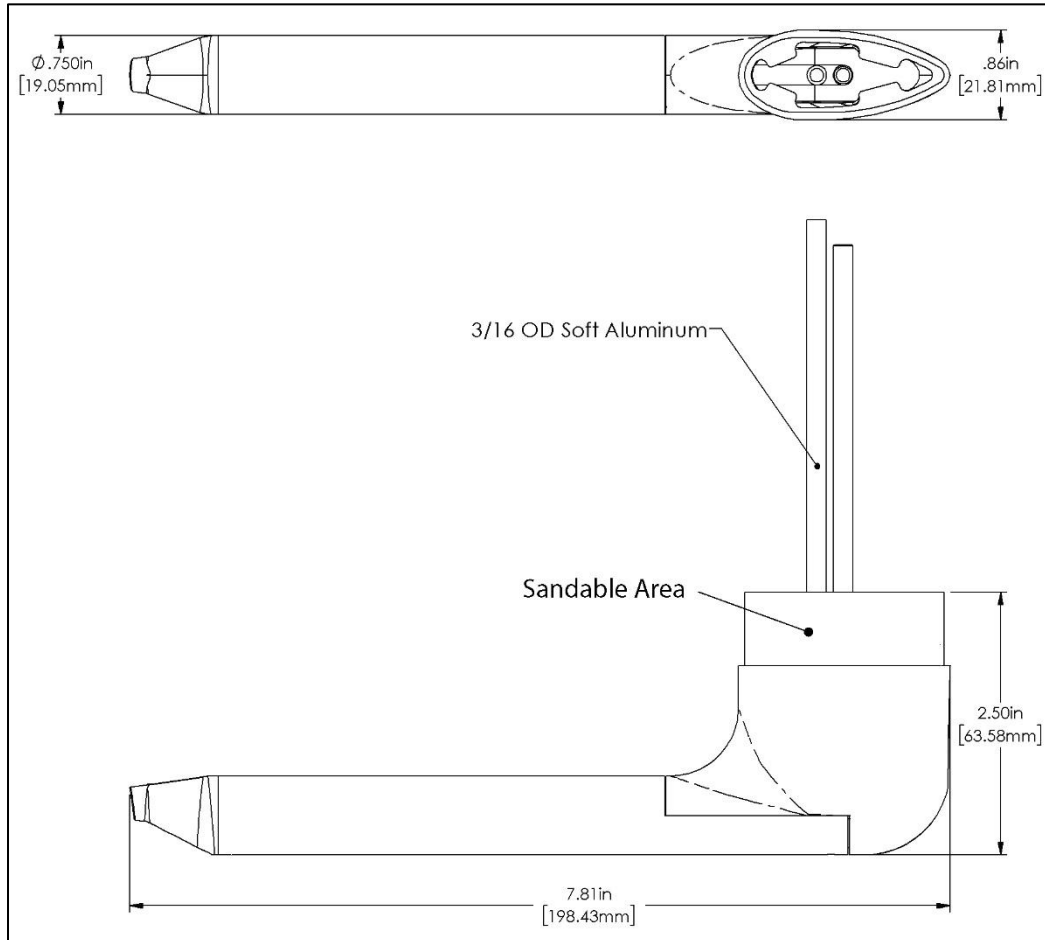

Figure 12 – AOA/Pitot Probe Dimensions

## Plumbing



Because the pitot and AOA plumbing tubes have not been annealed, they work-harden rapidly when manipulated. Make gentle bends, and only bend any given section *once*.



It is acceptable to split the Pitot input to both the Dynon Avionics EFIS unit / SkyView ADAHRS 200/201 and a standard airspeed indicator.



The plumbing instructions in this section are generalized. For specific connection instructions to your Dynon Avionics EFIS unit (EFIS-D6, EFIS-D10A, EFIS-D60, EFIS-D100, or FlightDEK-D180, see that product's Installation Manual. For SkyView, see the SkyView / SkyView SE System Installation Guide. These manuals can be downloaded from the Dynon Avionics website – [dynon.com/docs](http://dynon.com/docs).

For plumbing of the Pitot, Static, and AOA pneumatic lines, and a Static Port, Dynon Avionics offers the **Pitot/Static/AOA Pneumatic Installation Kit** (P/N 102628-000). This kit includes all required pneumatic components – 25 feet (7.62 meters) of tubing, fittings, a Static Port for installation on the fuselage, even a tubing cutter.

## Pitot/Static/AOA Pneumatic Installation Kit



Figure 13 – Contents of Dynon Avionics Pitot/Static/AOA Pneumatic Installation Kit (P/N 102628-000)



The instructions in this section is adapted from “AOA, Pitot, Static Installation Guide – Plumbing Kit, Document 102708-000, Rev. A that is included with this kit.

The following installation instructions are intended to make the task of plumbing this kit into your aircraft as easy and understandable as possible. If there are questions which you find are not answered within these instructions, please feel free to email or call Dynon Avionics Technical Support (contact information at the front of this manual) for assistance. Photos sent via email are very helpful and can improve our understanding of your situation or issue.













For quick reference:

**Blue tubing** is intended for use with the ANGLE OF ATTACK (AOA) port.

**Green tubing** is intended for use with the PITOT port.

**White tubing** is intended for use with the STATIC port

Kit Contents				
Dynon Avionics P/N	QTY	Part Description	Part Symbol	Part Image
102631-000	6	Straight Male		
102631-001	2	Elbow Male		
102639-000	3	Y-Union		
102639-001	1	T-Union		
102559-000	2	Static Air Port		



102632-000 102632-001 102632-002	25 ft. 25 ft. 35 ft.	Polyethylene Tube Blue (-000) Green (-001) White (-002)	BLUE GREEN WHITE	 AOA  Pitot  Static
102642-000	30	Snap Bushing	N/A	
102641-000	1	Tubing Cutter	N/A	
102630-000 102645-000 102643-000 102644-000	2	Flared Coupling Assembly		See Below
				

**Table 4 – Inventory Contents of Dynon Avionics Pitot/Static/AOA Pneumatic Installation Kit – Inventory**

*Please read this installation information in its entirety before beginning your installation of your AOA/Pitot/Static pneumatic system. Modifications or adjustments may be necessary for your individual aircraft.*

The Dynon Avionics Pitot/Static/AOA Pneumatic Installation Kit uses Quick-Disconnect fittings for the plumbing of this kit. Tubing is mounted into these fittings using stainless steel retainers that allow tubing to enter the fitting but prevent the tubing from sliding back out unless the retainers are properly retracted by pressing the outer release ring. This allows for connection, disconnection, and reconnection of tubing easily with only one hand. A fresh cut of the tubing with the supplied tubing cutter is recommended before re-inserting the tubing. With the use of these Quick-Disconnect fittings, maintenance and instrument removal are made significantly easier from the standpoint of a builder such as yourself.

#### **RECOMMENDED TOOLS**

Dynon Avionics has tried to provide you with as many parts and tools as necessary to make the tasks involved in installing your Dynon Avionics Pitot/Static/AOA Pneumatic Installation Kit go more smoothly. Tools that Dynon Avionics recommends for installations that use different tubing are listed below along with an optional retailer to purchase them from if necessary.

Aviation Grade Flaring Tool (37 degrees)

[https://www.aircraftspruce.com/menus/to/tubing\\_flaring.html](https://www.aircraftspruce.com/menus/to/tubing_flaring.html)

Or search “flaring tool” from any trusted aircraft retailer



Automotive or other non-aviation grade flaring tools will cause aluminum to work harden and fail due to flaring in excess of 37 degrees. Dynon Avionics strongly recommends using trusted tools designed specifically for aircraft.

Unique and additional fittings are available through Coast Pneumatics and can be ordered here-  
<http://www.coastpneumatics.com>

#### **INSTALLATION**

##### **Static Port**



Two static ports are provided in the Dynon Avionics Pitot/Static/AOA Pneumatic Installation Kit; one to mount on each side of the aircraft, to further increase accuracy in pressure readings.



**Figure 14 – Static Ports**

Static air pressure is obtained through both of the static port fittings mounted into the side of the aircraft. The static port fittings should be mounted appropriately and in accordance with the specific aircraft – in a place where the port can access relatively undisturbed air flow. The static ports furnished as part of the Dynon Avionics Pitot/Static/AOA Pneumatic Installation Kit are designed to be mounted “proud of” (slightly projecting from) the aircraft skin, in order to provide more accurate readings.

After the placement of the static port is determined, verify there is enough room inside the aircraft for the flange and fitting of the static port. Drill a ½” (12 mm) diameter hole from which

the static port will protrude. The circular groove on the back side of the port is meant to help with the alignment and drilling of 2 to 4 evenly spaced rivets. Another option is to use a compound, such as Pro-Seal, to mount the static port and seal out moisture.

### **Structural Penetration and Pass-Thru**

30 snap bushings have been provided in this kit to make plumbing within the fuselage and passing through internal structures easier and reduce possible chafing of the tubing. Once a 3/8" (~9.5mm) diameter hole is drilled through the structure that needs to be bypassed, the snap bushing can be installed by pushing it into the hole. The tubing will fit snugly through the snap bushing and eliminate the possibility of chafing. Do not route tubing through a bulkhead without using a snap bushing.

### **Tubing**

The most important consideration when installing tubing for the AOA, Pitot, Static system is to avoid damage or deformation of the tubing. The tubing cutter provided in the kit is an excellent way to ensure the tubing will not be crushed or given a jagged edge that scissors or other cutting tools might produce. Poor cuts can lead to leaky tubes or damage to the fitting to which they are connected. These leaks may not be obvious at first but can develop over time.

When connecting a tube to a fitting it is important to ensure that the tubing is completely sealed in and has bottomed out. Push the tubing into the fitting until you feel it stop. Push with more pressure and the tube will slide in further and finally bottom out. One way to ensure the tube has been pushed in all the way is to draw a small mark 1/2" (12mm) up from the end of the tubing going into the fitting. When the tubing is fully inserted into the fitting that mark should fall completely below the lip of the fitting and no longer be visible.

Terminating the AOA, Pitot, Static lines into an SV-ADAHARS-200/201 is discussed in the EFIS-D6, EFIS-D10A, EFIS-D60, EFIS-D100, FLIGHTDEK-D180 Installation Guide, or SkyView / SkyView SE System Installation Guide.

On the Dynon Avionics AOA/Pitot Probe and Heated AOA/Pitot Probe, at the base of the probe, the aluminum tube closest to the snout is the Pitot line. At the base of the probe, the aluminum tube to the rear of the Probe is the AOA line.



Before installing the AOA/Pitot Probe, verify that there are no restrictions (contaminants, dirt, debris, etc.) in the probe:

1. Blow into the Pitot port (the tip of the probe) and verify good airflow comes out of the Pitot line (closest to the tip).
2. Blow into the AOA port (underneath the tip) and verify good airflow comes out of the AOA line (closest to the rear of the probe).

Route the Pitot and AOA pneumatic lines from the EFIS unit or SkyView SV-ADAHRS-200/201 to the Dynon Avionics AOA/Pitot Probe / Heated AOA/Pitot Probe (or vice versa).



It is easy to get the AOA pneumatic line and the Pitot pneumatic line reversed during final installation. Before installing the pneumatic lines, make a positive indication on both ends of one or both lines, such as putting a tag on *each* end of *each* pneumatic line indicating which line is which - AOA and Pitot.

Install any needed adaptors to connect the probe's 3/16" aluminum plumbing lines to the pneumatic lines; example AN 919-2D for adapting the 3/16" aluminum lines to 1/4" lines. We strongly recommend using aircraft-grade fittings such as standard AN fittings. Take care to ensure that the plumbing lines will not chafe and will not interfere with any aircraft control systems.

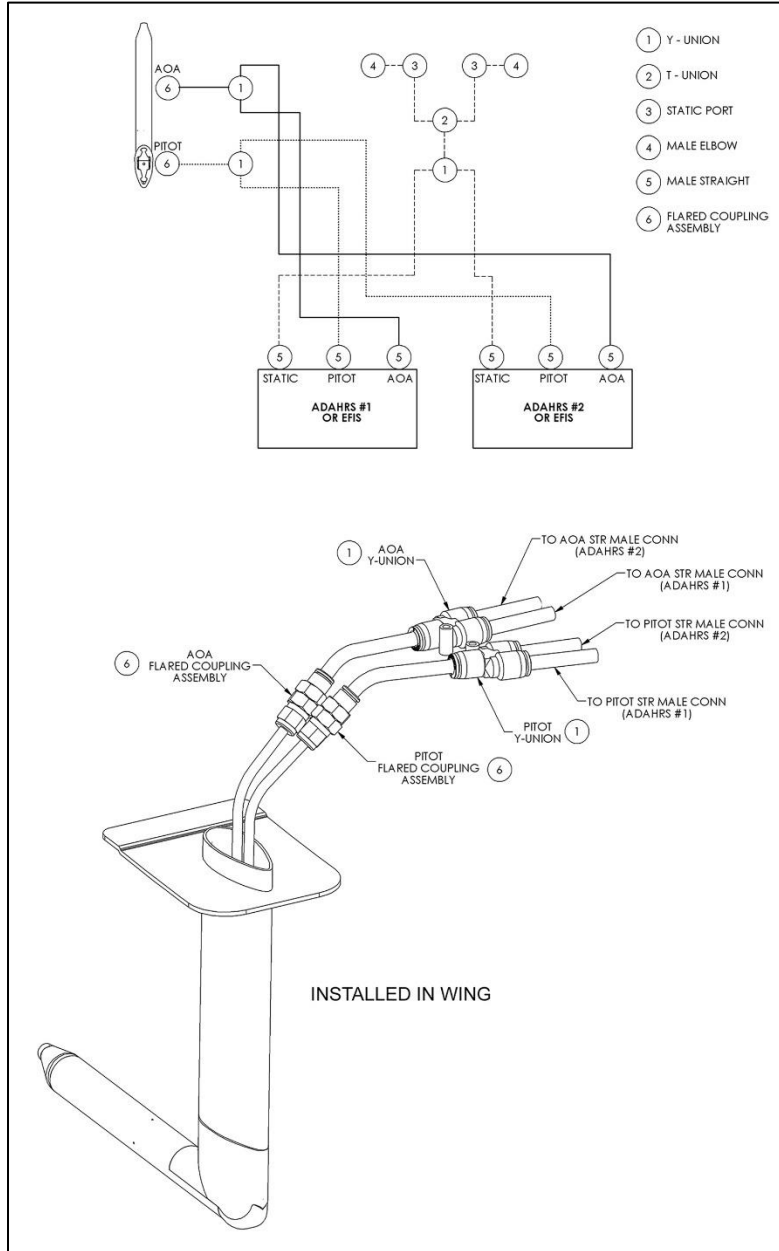

Figure 15 – Schematic Diagram of Pitot and AOA Plumbing Installation

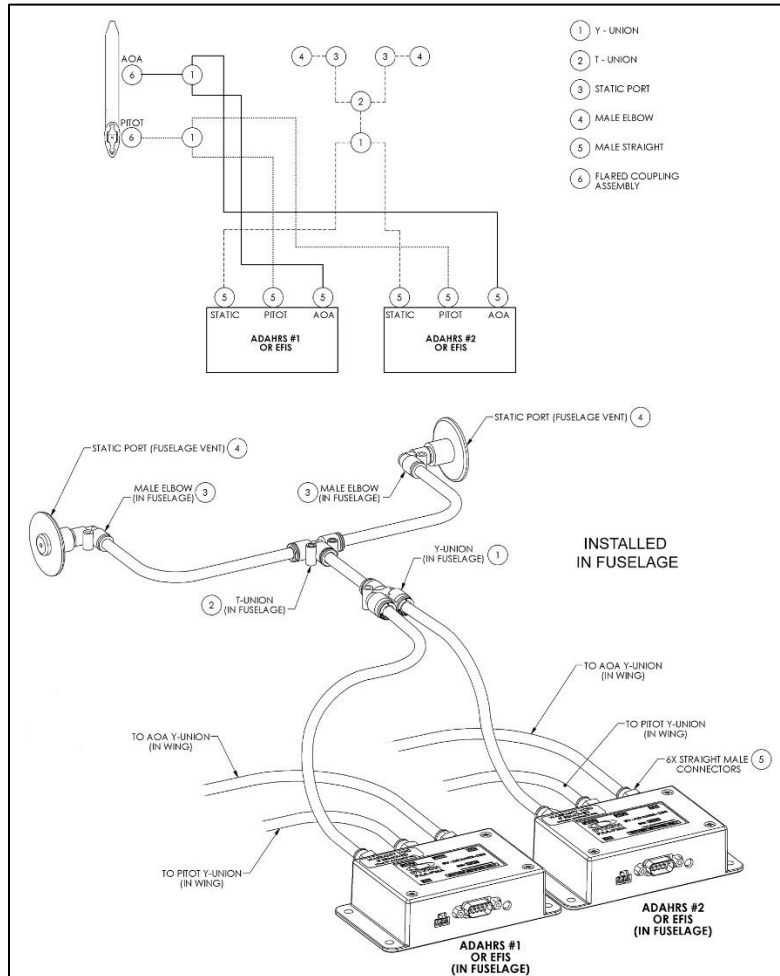

Figure 16 – Schematic Diagram of Static Plumbing Installation

### MOISTURE DRAINAGE

The Dynon Avionics AOA/Pitot Probe and Heated AOA/Pitot Probe incorporate pin-sized moisture drainage holes on the underside of the probe. The moisture drainage holes do not affect the performance of the probe.



Although the Dynon Avionics AOA/Pitot Probe and Heated AOA/Pitot Probe incorporate a robust moisture separation and drainage design, the builder/installer should ensure that the design and installation of the overall AOA / Pitot system provides positive drainage of moisture from the *entire* AOA / Pitot / Static system.



It is recommend to add the following to your preflight inspection checklist: *Check the two small drain holes on the underside of the AOA/Pitot Probe. They should be unobstructed – free of corrosion or other debris.*

### **PRESSURE CHECK**

As explained above, the Dynon Avionics AOA/Pitot Probe / Heated AOA/Pitot Probe incorporate pin-sized moisture drainage holes in the AOA line and the Pitot line.

Plugging these holes on the exterior of the probe (such as applying tape over them) will *not* guarantee a pneumatic seal (although one is sometimes present). The presence of the drain holes must be taken into account when doing pressure/leak tests on your AOA / Pitot system – it may be necessary to temporarily disconnect the probe and plug the AOA and Pitot lines.

### **HEATED AOA/PITOT PROBE – HEATER CHECK**

A simple test ensures that the Heated AOA/Pitot Probe's heater is working:

- Turn power on to the Heated AOA/Pitot Probe,
- Wait one minute for the pitot to allow the Probe to warm to operating temperature,
- Briefly (very briefly – it will likely be hot) touch the snout and verify that it is warm.

### **HEATED AOA/PITOT PROBE – PITOT HEAT STATUS INDICATOR CHECK (IF INSTALLED)**

A simple test ensures that the Heated AOA/Pitot Probe PITOT HEAT STATUS Indicator is working:

- Turn off the switch or circuit breaker powering the Heated AOA/Pitot Probe
  - The PITOT HEAT STATUS indicator should illuminate
  - If displaying PITOT HEAT STATUS on a Dynon Avionics EMS unit or SkyView EMS page, the indicator should be Red.



For future reference, before completing the installation, be sure to record the P/N and S/N of the AOA/Pitot Probe, Heated AOA/Pitot Probe, and Heated AOA/Pitot Probe controller in the build log or the airframe log.

### **POLISHING YOUR DYNON AVIONICS AOA/PITOT PROBE**



Do not get the polish into any of the drain holes, Pitot port, or AOA port. Doing so could cause a serious problem with the accuracy of Airspeed and AOA.

To polish your Dynon Avionics AOA/Pitot Probe, we recommend "Mother's Mag and Aluminum Polish."

This page intentionally left blank.



## 6. AOA CONFIGURATION AND CALIBRATION

---

The Dynon Avionics AOA/Pitot Probe / Heated AOA/Pitot Probe is designed solely for use with Dynon Avionics EFIS units, Dynon Avionics SkyView system, and Advanced Flight Systems AOA and EFIS products. Installation manuals for all Dynon Avionics products can be found at [dynon.com/docs](http://dynon.com/docs). Installation manuals for Advanced Flight Systems products can be found at [advancedflightsystems.com](http://advancedflightsystems.com).

After installation of the AOA/Pitot Probe / Heated AOA/Pitot Probe is complete, a calibration procedure must be performed in flight. Each aircraft, each installation is unique; the AOA calibration procedure ensures that AOA will be displayed accurately for your airplane's specific flight characteristics. Instructions for AOA calibration are contained in the Installation Manual for Dynon Avionics EFIS units, the Dynon Avionics SkyView / SkyView SE System Installation Guide, and manuals for Advanced Flight Systems products.

Similarly, options for configuring the display of the on-screen AOA indicator, optional AOA audio warnings, and other settings related to AOA vary by product and version of firmware installed on your system – see the Installation manual for configuration details related to AOA.

---

This page intentionally left blank.

## 7. SPECIFICATIONS

---

### **Pitot Mount for RV 7, RV-8, RV-9, RV-10 P/N 102813-000**

Weight:..... 0.30 lb. (0.14 kg)  
Pitot Mounting:..... AN5812 type mast  
Finish: .....Gold Chem Film Plating

### **AOA/Pitot Probe P/N 100141-000**

Weight:..... 0.35 lb. (0.18 kg)  
Tubing Connection:.....3/16" OD aluminum  
Pitot Mounting:..... AN5812 type mast (*not provided*)  
Moisture Protection:..... Dedicated drain hole provided for each line  
Finish: ..... Nickel-plated  
Operating Temperature:..... -60°C to 100°C

### **Heated AOA/Pitot Probe P/N 100667-000**

Weight:..... 0.4 lb. (0.18 kg)  
Tubing Connection:.....3/16" OD aluminum  
Pitot Mounting:..... AN5812 type mast (*not provided*)  
Moisture Protection:..... Dedicated drain hole provided for each line  
Finish: ..... Nickel-plated  
Operating Temperature:..... -60°C to 100°C

### **Heated AOA/Pitot Probe Controller**

Weight:..... 0.32 lb. (0.15 kg)  
Power: ..... 100 watts @ nominal 13.8 V / 10 A  
Operating Temperature: ..... -40°C to 70°C

***Go Fly!***